

GENE CAFE

COFFEE BEAN ROASTER

CBR-301

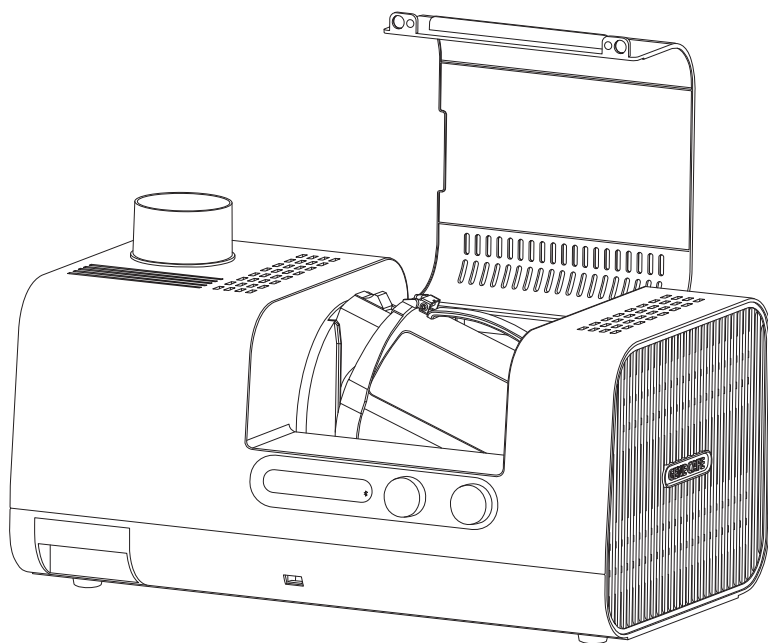

User Manual (Rev.01)

www.genecafe.co.kr

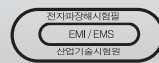

01. Table of Contents

01. Table of Contents	2p
02. Introduction	3p
03. Features	4p
04. Configuration	5p
05. Caution	6-7p
06. Parts Name and Functions	8-9p
07. How to Use	10p
1)Preparation Before Roasting	10-11p
2)Connecting Power and Setting Time	12p
3)Setting the Temperature and Start Roasting	13p
4)Display while Roasting	14p
5)Cooling and Finish Batch	15p
6)Finish Roasting	16p
08. Mobile Application	17p
09. Cleaning and Maintenance	18-19p
10. Trouble Shooting	20p
11. Error Messages Emergent Measures	21p

02.Introduction

This product is a coffee roaster for home and business use and is based on the most advanced technology with national and international patents.

Please read this manual carefully before use, and familiarize yourself with the proper use, cleaning and maintenance, and roasting of the product before using it.

For your convenience, please do not throw away this manual and keep it.

Model Name		CBR-301
Stirring method		Vortex twisting (off-axis rotation)
Heating method		Indirect hot air
Temperature setting range		60°C ~ 260°C (140°F ~ 500°F)
Temperature control		Electronic thermostats
Rated voltage		120V - 60Hz
Mobile integration		Bluetooth pairing
Chamber	Material	Heat resistant tempered glass tube (PYREX)
	Capacity	300g (Max)
Power consumption		1.5kW
Noise		70dB or less
Product size		496x276x277(H)mm
Product weight		7.3kg

※Design and product specifications are subject to change without notice to improve quality.

03.Features

Connection by Bluetooth

Mobile integration is possible via Bluetooth function.

Overheat protection

Automatically shuts off the heater if the internal temperature gets too hot, keeping you safe.

Automatic cooling system

Automatically cools the beans after roasting is complete.

Innovative 3D Agitation (patented)

Off-axis divided rotating chamber ensures efficient and even roasting. Patent pending.

Visual inspection

The heat-resistant glass tube allows you to visually check the roasting of the beans.

Excellent design

The sleek design provides a great visual match.

Large capacity chamber

From 100g up to 300g for even roasting regardless of capacity.

Indirect hot air

The indirect hot air heating method ensures that the coffee is roasted evenly from the inside out.

Easy maintenance

Easy chaff cleaning

04. Configuration

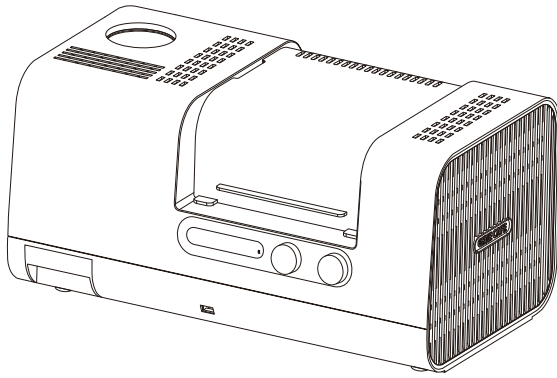

Main Body

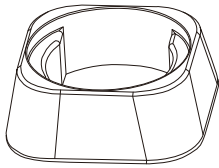

Chamber stand

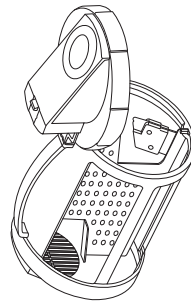

Chamber



Vent pipe connector

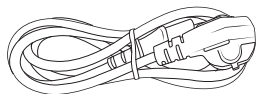

Power plug



Manual

05. Caution

IMPORTANT SAFEGUARDS

This is to protect the user's safety and prevent property damage in advance. Please read this carefully before using the product and use it correctly.

When using this product, basic safety precautions should always be followed including the following:

1. Read all instructions.
2. Do not touch hot surfaces. Wear gloves.
3. To protect against electrical shock do not immerse cord, plugs, or products in water or other liquid.
4. Close supervision is necessary when any appliance is used by or near children.
5. Unplug from outlet when not in use and before cleaning. Allow to cool before putting on or taking off parts.
6. Do not operate any appliance with a damaged cord or plug or after the appliance malfunctions or has been damaged in any manner. Return appliance to the nearest authorized service facility for examination, repair, or adjustment.
7. The use of accessory attachments not recommended by the appliance manufacturer may cause injuries.
8. Do not use outdoors.
9. Do not let cord hang over edge of table or counter, or touch hot surfaces.
10. Do not place on or near a hot gas or electric burner, or in a heated oven.
11. Extreme caution must be used when moving an appliance containing hot oil or other hot liquids.
12. Always attach plug to appliance first, then plug cord into the wall outlet. To disconnect, turn any control to "off", then remove plug from wall outlet.
13. Do not use appliance for other than intended use.
14. Using the product on an inclined surface can cause problems with roasting and the product, and can also create a fire hazard, so always use it on a level surface.
15. When used in dusty environments, please keep the surrounding environment clean as debris may enter the fan and cause malfunction.
16. Do not touch the outlet and do not place flammable materials near it, as the temperature of the peel box smoke exhaust is very high, creating a burn and fire hazard.
17. Do not block the openings of the product and peel box with foreign objects such as tissues. Causes fire and product failure.
18. Never place foreign objects, such as metal sticks, inside the product. Causes electric shock and safety hazards (especially for children).
19. If foreign objects (cloth, paper, fingers, etc.) become entangled in the rotation of the roaster, immediately unplug the power plug to stop rotation and remove the foreign objects.
20. Unplug the power cord in case of emergency.
21. Do not use it with other heating appliances, as the roasting may not proceed due to insufficient voltage.
22. Use an extension cord that is rated for at least the current rating.

05. Caution

23. If the power cord is broken, have it replaced by a qualified technician or A/S representative.
24. Do not disassemble, repair, or modify by anyone other than a service technician.
25. The product may fail if used in direct sunlight or in areas with excessive heat.
26. When the roaster is removed from the base, always store it securely on its dedicated base.
27. If the roaster tilts and is not secured to a base, it can tip over and cause damage and safety hazards.
28. Never touch the metal parts of the base from which the roaster is removed, as they can cause burns.
29. Do not subject the product to severe shock or drop it from a height. Product failure and safety incidents can occur.
30. Do not pull or deform the blades on the dividers and the grilles on either side of the roaster.
31. Blade and grill deformations can result in poor peel ejection, resulting in uneven roasting or a risk of fire.
32. Never warm up this product. This can cause the product to fail.
Smoke and odors may be generated during roasting, so use in a well-ventilated area with a fan running.
33. If any abnormalities occur, please refer to 'what to do in case of problems' in this manual, and if the problem persists, please contact the A/S center at 031-415-6193.
34. If disassembled, repaired, or modified by anyone other than a service technician, you will not be eligible for free A/S even under warranty.

※ Before using the product, please familiarize yourself with the instructions and be sure to observe the following.



1. Always clean the chaff tray before use.
2. Clear away anything that might interfere with rotation.
3. Fumes may be generated, so use in a well-ventilated area. (Ventilation)
4. Make sure there are no flammable materials, children, or pets nearby.
5. Keep a fire extinguisher nearby in case of fire and **never leave the product unattended.**
6. Roasting results may vary depending on the input voltage, and use within $\pm 5\%$ of the rated voltage.
7. Keep the temperature above 20°C, as lower ambient temperatures can cause problems with roasting.
8. This product uses an indirect hot air heating method so the temperature rises gradually and separate moisture blowing or preheating is not required. On the contrary, improper warm-up can reduce product durability.

SAVE THESE INSTRUCTIONS

06. Parts Name and Functions

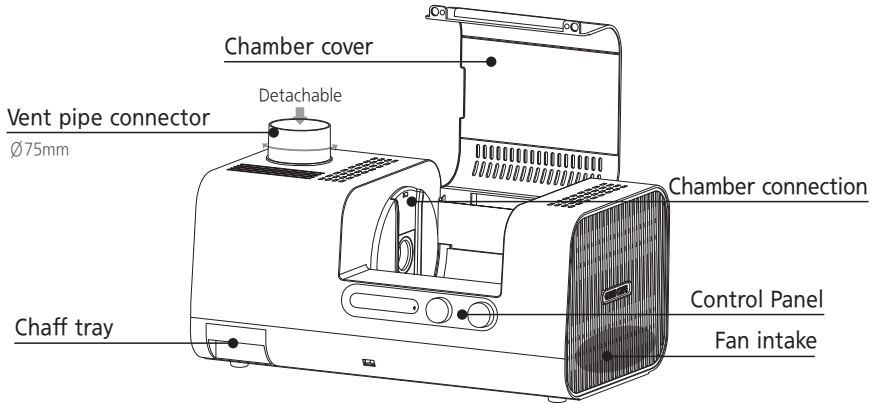

Fan intake This is where outside air is taken in. Allow enough space to avoid obstructing inhalation.

Chamber cover This is where outside air is taken in. Allow enough space to avoid obstructing inhalation.

Vent pipe connector Connect the flue to where the smoke generated during roasting can be exhausted to the outside.

Chaff tray This is where the peels generated during roasting are collected in one place. There is a risk of fire, so empty it immediately after roasting.

Chamber connection This is the groove where you insert the chamber

Control panel You can power it on and off. You can set the temperature and time.

Chamber stand Roasters can be stored safely.

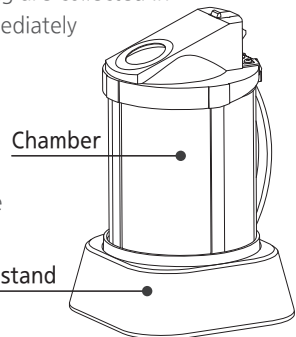

06. Parts Name and Functions

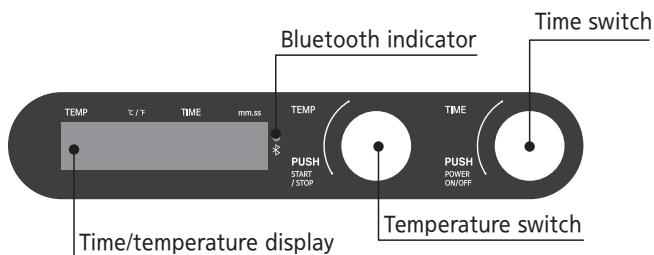

Time/temperature display Displays the roasting and cooling time/temperature.

Bluetooth indicator Displays the Bluetooth connection status.

Temperature switch ① Set and change the temperature (rotate left and right)
② Start/emergency stop roasting and cooling (press the switch)

Time switch ① Set and change the time (rotate left and right)
② Power ON/OFF (press the switch)

Release Button Use to separate the roaster from the base.

Chamber lid Use when adding green beans or discharging roasted beans.

Outlet This is where the peel is ejected.

Blade cushion Mitigates blade impact to prevent glass tube breakage.

Separator This ensures that the coffee is evenly mixed and roasts evenly.

Inlet This is where the hot air comes into the roaster.

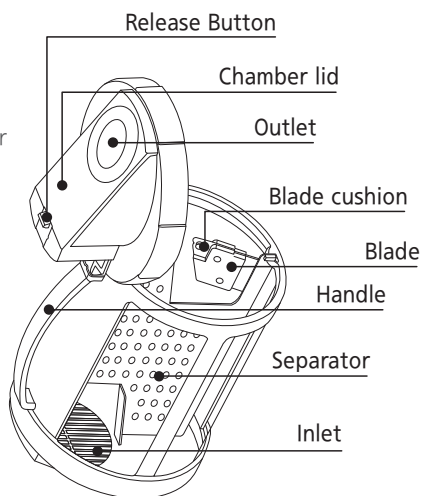

07. How to Use

01. Preparation Before Roasting



Keep a fire extinguisher nearby in case of fire and **never leave the product unattended.**

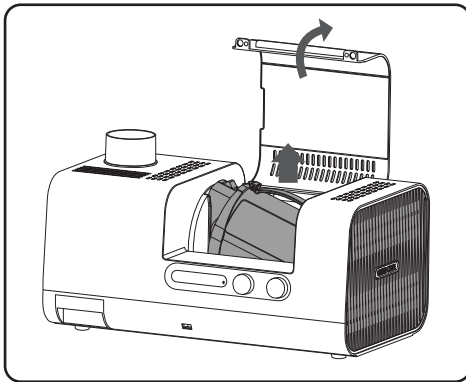

- 1 Open the chamber cover, grasp the roaster handle, press the release button, and lift up to remove it from the base.

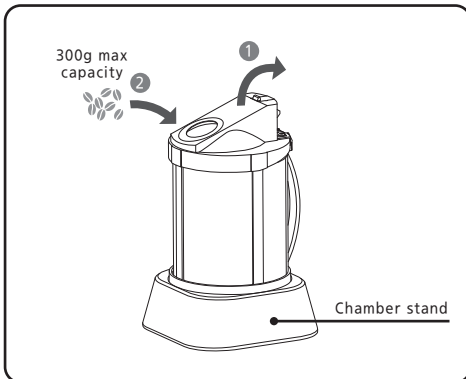

- 2 Place the chamber safely on its base and open the lid. Add the desired amount of green beans to the roaster.



• If you add more green beans than the maximum capacity, there is a risk of uneven roasting or fire, so be sure to stick to the 300g maximum per batch (240g for naturally processed green beans).

• Roasting with combustibles in the beans can cause a fire, so remove any combustibles from the green beans before roasting.

07. How to Use

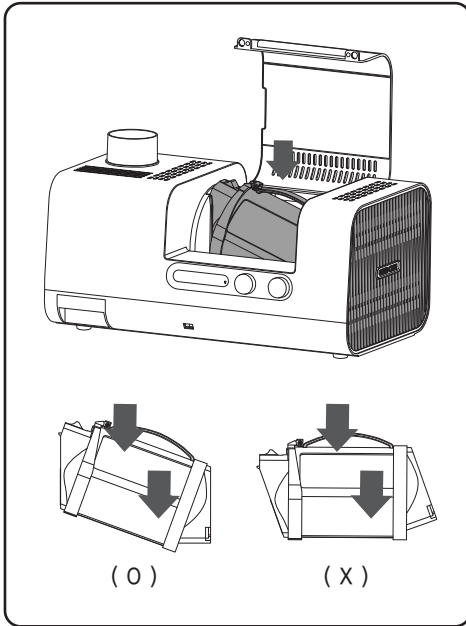

- 3** Close the lid of the chamber, hold it at an angle so that the lid is on the left side, align it with the guides on the base, and gently push it in until you hear a "click". Then, lift it slightly to make sure it doesn't fall out.



• Please note that product and safety issues may occur if the lid of the chamber is not fully closed or the roaster is not properly seated.

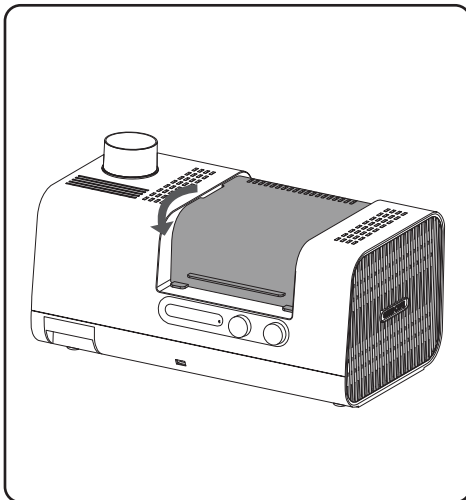

- 4** Be sure to keep the chamber cover closed. If the cover is open, it won't work.



• Always operate the appliance with the cover closed, as it is extremely dangerous to touch the roaster or insert foreign objects into it.
• To avoid the risk of product damage and safety hazards, always insert the chamber before using it.
• Be sure to equip the chaff tray before using it. If you use a bowl or wire meshes as a substitute for a chaff tray, there is a risk of fire, so be sure to use the standard product provided.

07. How to Use

02. Connecting Power and Setting Time

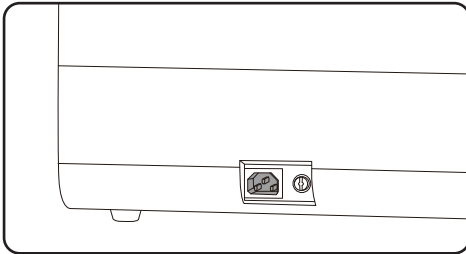

1

Connecting power

- Before using the product, be sure to check the voltage rating and connect the power.
- The rated voltage is different from each countries.



It is very dangerous to connect the wrong voltage, so be sure to check the voltage rating before connecting.

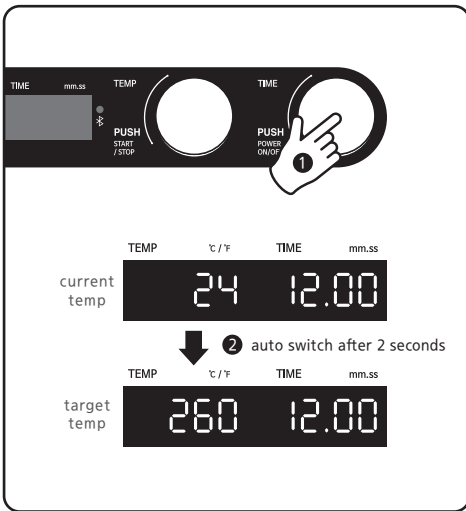

2

Power on

- ① Press the time switch to turn on the power.
- A buzzer will sound and the current temperature and target time will appear in the display.
- ② The current temperature is displayed for 2 seconds and then automatically switches to the target temperature.
- The settings at the start of the last roast are displayed, with a default setting of 260 degrees and 12 minutes.
- The buttons are not operable for the first two seconds after powering on.

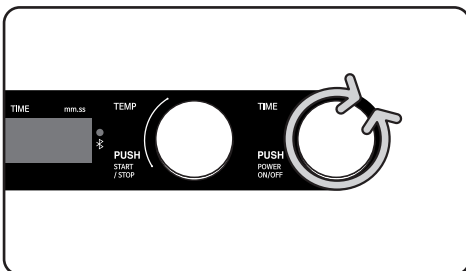

3

Setting time

- Turn the time switch to set the desired roasting time.
- Time settings range from 5 to 30 minutes and can be adjusted in 1-second increments.
- Flip the switch quickly to set it to 5-second increments.

07. How to Use

03. Setting the Temperature and Start Roasting

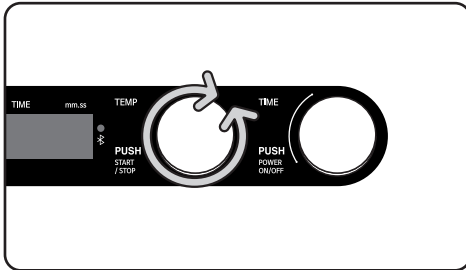

1 Temperature setting

- Turn the temperature switch to set the desired temperature.
- Temperature settings range from 60 to 260 degrees and are adjustable in 1-degree increments.
- Turn the switch quickly to set it in 5-degree increments.

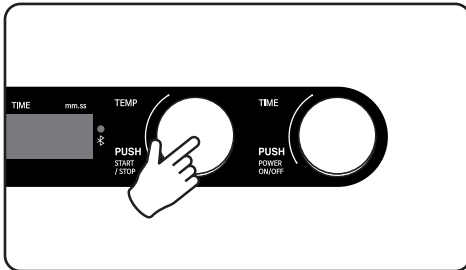

2 Start roasting

- Once you're done setting the temperature and time, press the temperature switch to start roasting.
- At this point, you'll hear a buzzer and the roaster will rotate to start heating.

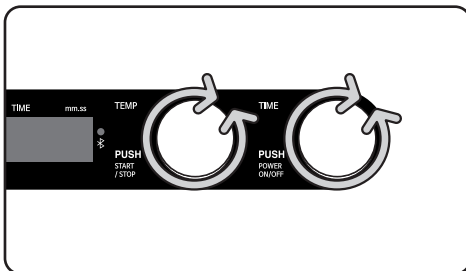

3 Change settings

- You're free to change the settings even while roasting.
- Turn the temperature and time switches left and right to change the temperature and time settings.
- Even during cooling, you can add more roasting time by turning the time switch to start reheating.

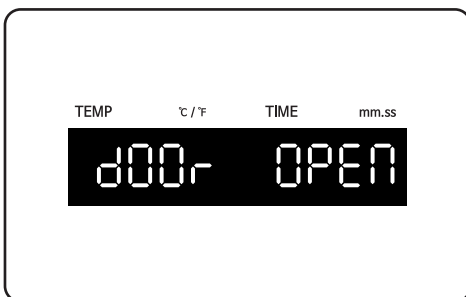

4 When the chamber cover is open during roasting

- Opening the chamber cover during roasting will pause the roasting and the messages 'DOOR', and 'OPEN' will be displayed along with a buzzer sound.
- When you close the roaster lid, the buzzer stops and the roasting continues.

07. How to Use

04. Display while Roasting

Time/temperature display contents

1 Temperature display (TEMP)

The current temperature is displayed for 3 seconds and the set temperature for 1 second alternately.

※ When the dot (.) is displayed, it is the current temperature.

2 Time display (TIME)

The elapsed time is 3 seconds and the set time is 1 second alternating.

Separate minutes and seconds with a dot (.) between the second and third digits.

※ The current time is the time when the last dot (.) is displayed, and the dots (.) in between are blinking.

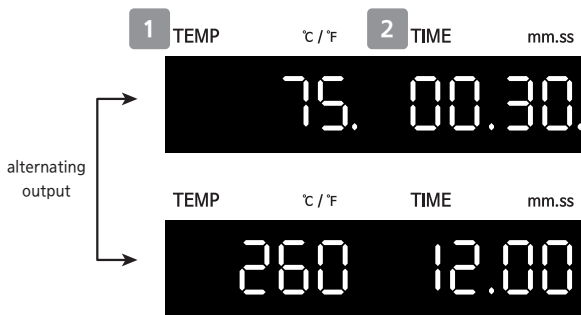

Out-of-place protection function

When the device reaches the set temperature, it beeps and automatically enters cooling mode if the switch is not operated within 30 seconds.

- The first beep sounds when the temperature reaches 200°C (392°F). If the temperature switch is not pressed within 30 seconds, it will automatically switch to cooling mode.
- A second beep sounds when the temperature reaches 230°C (428°F). Again, if the temperature switch is not pressed within 30 seconds, it will automatically go into cooling mode.
- If the temperature switch is pressed within the time limit, the beep will be canceled and the roast will continue.

05. Cooling and Finish Batch

Manual cooling start

TEMP °C / F TIME mm.ss
COOL Cooling elapsed time

TEMP °C / F TIME mm.ss
 Current temperature Cooling elapsed time

Alternating output

- 1 Start cooling
 - Cooling starts automatically after the set time has elapsed.
 - Even during roasting, you can manually start cooling by pressing the temperature switch.
 - During cooling, the temperature display will alternate between 'COOL' and the current temperature, and the time display will show the elapsed cooling time.

Caution • When auto-cooling, the residual heat will cause further roasting, so cooling should be started before the target roasting point.

Manual Cooling End

TEMP °C / F TIME mm.ss
STOP Cooling elapsed time

TEMP °C / F TIME mm.ss
COOL End

- 2 Finish cooling
 - When the current temperature reaches 60 degrees, it will automatically finish and stop working with a buzzer.
 - Even during cooling, you can press the temperature switch to automatically shut down cooling. On manual shut down, the cooling fans run for an additional 10 seconds before stopping.
 - When cooling is complete, the roaster will automatically return to its home position and stop, with 'STOP' flashing in the temperature display. When the roaster comes to a complete stop, you will see the message 'COOL' and 'End'.

Force quit function

long press to force exit

If you need to urgently stop operation during roasting or cooling, press and hold the time switch to stop all functions immediately, forcing the unit to shut down.
 (However, to be safe, wait until the chamber has come to a complete stop in its home position)

07. How to Use

06. Finish Roasting

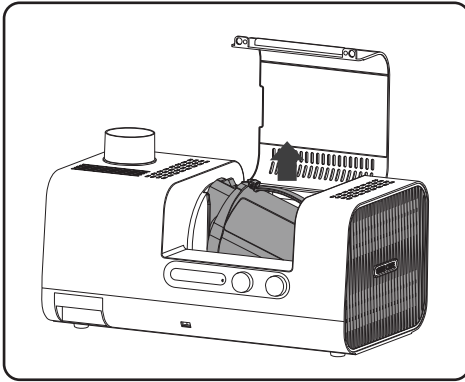

- 1 Once the chamber has finished cooling and has returned to its original position and stopped, press the release button on the chamber and lift it up to separate it from the base.



• Even after cooling, heat remains in the chamber, so be sure to handle it with gloves and avoid burns.

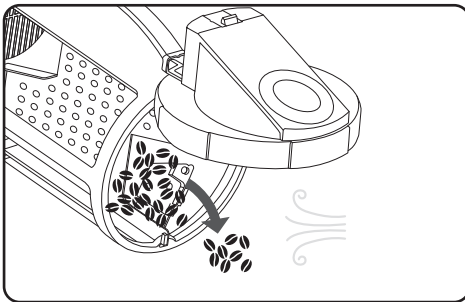

- 2 Open the lid of the chamber from the base and pour the beans onto a prepared wire mesh or tray for residual cooling in the air. (You can use an electric fan or fan, etc. to cool down more quickly)



• Be especially careful with the chamber and roasted beans after an emergency stop, as they are extremely hot and can cause safety hazards and burns.

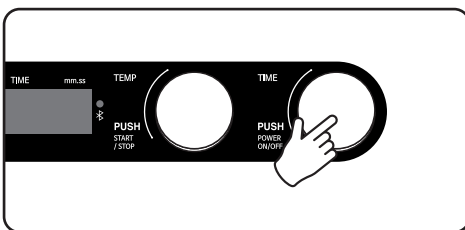

- 3 Press the time switch to turn off the power and unplug the power plug from the outlet.



• Automatic power off (power saver)
The Product will automatically power off with a buzzer after 3 minutes of inactivity.

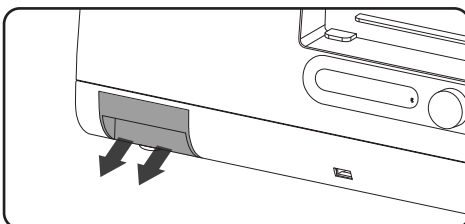

- 4 Pull the chaff tray forward and away from the base and empty the chaff that have accumulated in the tray.

08. Mobile Application

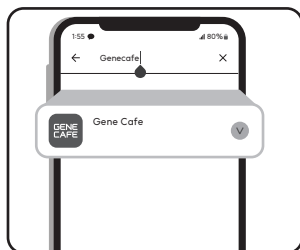

1 APP Installation

- Search for "Gene Cafe" in the Play Store (Android) or App Store (iOS) on your mobile device and install it.
 - ※ Minimum supported OS version
- Available for Android 10 and iOS 13 and higher OS versions.
- If you're using a device older than Android 10 and iOS 13, we recommend that you update your OS to the latest version.



- For Bluetooth connection, location services and Bluetooth functions on your mobile device must be enabled.
- Before connecting your device, we recommend that you power on your roaster and have it close at hand. Be aware that you may lose your connection if the distance increases.
- Only one mobile device can be connected to the roaster at a time.
- Bluetooth connections can be unstable if there are a lot of electronics or wireless signals around, so try to use it in an environment with as little interference as possible.
- During roasting, periodically check the Bluetooth connection status, and if the connection is unstable, we recommend manually manipulating it.
- Bluetooth can drain your mobile device's battery quickly, so check the battery status periodically.

2 Launch the app

- When the installation is complete, launch the app.
 - ※ On the first launch, you may be asked for permission to use the service. Please allow the necessary permissions for Bluetooth connectivity.

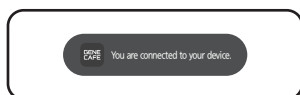
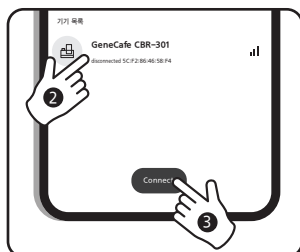
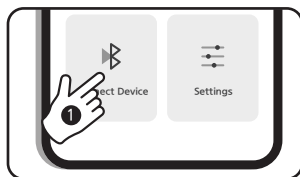

3 Connect your device

- ① On the app's main screen, click the connect device menu.
- ② The app will search for nearby roasters, and when the list of available roasters appears, click the roaster model you want to connect to.
- ③ Tap the Connect button at the bottom of the list to try to connect.
 - ※ If multiple GeneCafe roasters are found, check the MAC address on the label at the bottom of the machine to select the desired machine.
- ④ When the connection is complete, you will see the message "Connected to your device" on the screen, and at the same time, the Bluetooth light on your device will turn green.

Once the roaster is connected, you can monitor and control the machine in real-time from the Roasting menu.

09. Cleaning and Maintenance

The product is for household use.

01. Chamber

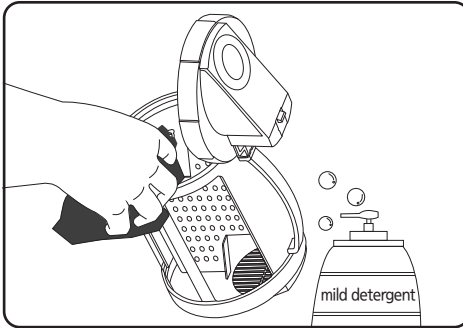

- 1 After roasting, clean the chamber with soap or mild detergent, rinse with warm water, and dry thoroughly before storing, as oil and debris left in the roaster can affect the taste and aroma of the coffee or cause errors in determining the roast color.



• Be sure to wear gloves, as sharp parts can cause injury or break the glass tube.

02. Chaff box



• A clogged chaff box exit can cause problems with the heater and roasting. Also, be sure to empty the chaff after each use, and clean the wire mesh holes after about 10 uses, as they can cause smoke, odor, dust, and fire.

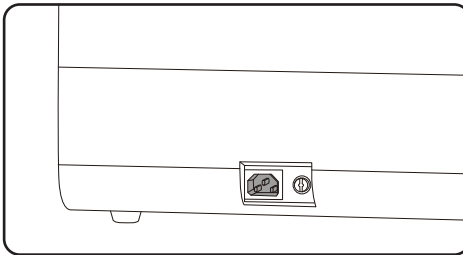

- 1 Before you begin cleaning, be sure to power off the product and unplug the power plug from the outlet.

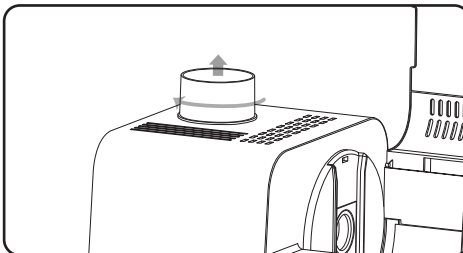

- 2 Rotate the vent pipe connector clockwise to disconnect it from the base.

09. Cleaning and Maintenance

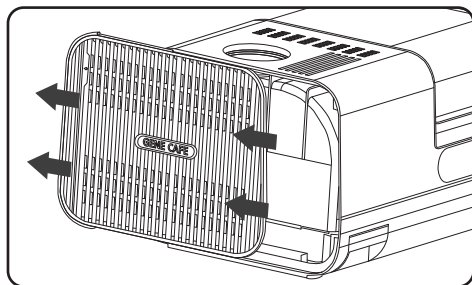

- 3** Slide the side cover to the side to remove it from the base.



Caution

• Do not open the left side cover except for cleaning. Be sure to unplug the power plug from the outlet before opening the side cover.

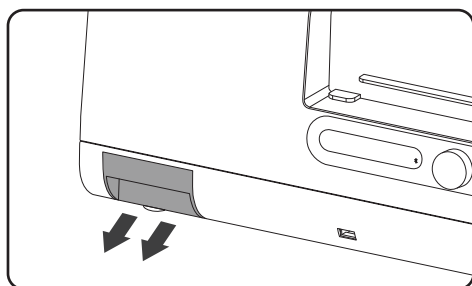

- 4** Pull the chaff tray forward to release it from the base.

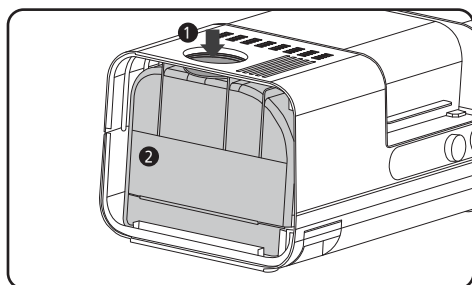

- 5** ①Press the top of the chaff box body to unlock it, then ②rock it from side to side to remove it from the body.



Caution

• Make sure the wire mesh is not clogged with micro chaff, etc., and clean the wire mesh openings.

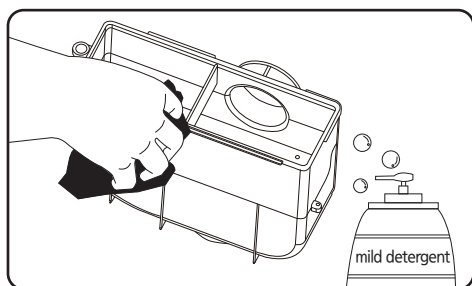

- 6** Clean it with a mild detergent and let it dry completely before using it.



Caution

• Be careful and always wear gloves, as sharp parts can cause injury.

※When assembling the chaff box body, fully engage the top piece until it "clicks" together.

10. Trouble Shooting

If you don't use it correctly, it may not work properly, even if it's not broken. If something isn't working properly or there is something wrong with the product, check the checklist below and if the problem persists after taking action, contact our service center.

Phenomena	Probable cause	What to do
The power does not turn on.	<ol style="list-style-type: none"> 1. Connecting to power 2. Fuse disconnects 3. Not familiar with how to use 	<ol style="list-style-type: none"> 1. Plug the power plug into an outlet. 2. Please exchange the fuse. 3. Please read the documentation to familiarize yourself with its use.
The temperature isn't as high as usual.	<ol style="list-style-type: none"> 1. Is the voltage appropriate? 2. Over-roasting green beans 3. Roasting conditions per green bean (incorrect roasting settings) 4. Chaff box clogging 5. Clogged fan intake 6. Other heating appliances 	<ol style="list-style-type: none"> 1. Check the voltage rating. 2. Add the appropriate amount of green beans. 3. Set the appropriate roasting conditions based on the type of green bean. 4. Clean the Chaff box. 5. Remove anything that is blocking the fan intake. 6. Do not use it with other heating appliances.
It doesn't stop working.	<ol style="list-style-type: none"> 1. Product cooling 	<ol style="list-style-type: none"> 1. If the product doesn't cool down enough, it won't stop. 2. It stops at 60°C. 3. Press the temperature switch. Cooling ends immediately.
The chamber doesn't fall out.	<ol style="list-style-type: none"> 1. Release button 2. Check chamber direction 	<ol style="list-style-type: none"> 1. Press the release button and lift it up. 2. Make sure the chamber handle is pointing upward.
The chamber won't fit.	<ol style="list-style-type: none"> 1. Check chamber direction 2. Chamber lid closed 	<ol style="list-style-type: none"> 1. Place the chamber lid facing left and gently insert it into the grooves on the base. 2. Make sure the lid of the chamber is completely closed.

11. Error Messages and Emergent Measures

01. Error display and content

Error display	Contents	Remarks
E1	Check the outlet temperature sensor	Contact our service center.
E2	Exit temperature overheat detection	
E3	Check the motor	
E4	Check the heater or fan	

※ Press the time switch to clear the error and turn off the power.

02. Emergent measures

IMPORTANT SAFEGUARDS

■ In the event of an in-product fire

During roasting, the temperature inside the chamber or chaff box is very high, which can cause the beans and chaffs to catch fire.

If you experience a fire in your product, don't panic and follow the steps below.

1. Unplug the product to remove power.
2. Clear the area of any flammable materials.
3. If the fire is extinguished naturally, keep an eye on it until it is fully extinguished, and if it continues, extinguish it with a fire extinguisher.
4. In the event of a fire, be sure to contact our service center.

■ If the power is accidentally turned off

Immediately turn the power back on and when the chamber stops in place, remove the chamber or continue roasting.

■ When the power is off, such as due to a power outage

The heat inside the beans is elevated to high temperatures, creating a risk of injury and fire. After unplugging the power cord, stay away until it is completely cool and follow the instructions below in case of fire.

※ If the chamber does not stop at a fixed position, do not try to remove it forcibly; it will automatically rotate and stop at a fixed position when the power is turned on, so please remove the chamber at this time.

SAVE THESE INSTRUCTIONS

MEMO
